

Viscoelastic or Viscoplastic Glucose Theory (VGT #36): Applying the VEGT or VPGT to Study the Cancer Risk Probability Percentage Versus Medical Conditions and Lifestyle Details over 10+ Years from Y2012 to Y2022 Based on the GH-Method: Math-Physical Medicine (No. 617)

Gerald C Hsu

EclaireMD Foundation, USA

***Corresponding author**

Gerald C. Hsu, EclaireMD Foundation, USA

Submitted: 15 Jun 2022; **Accepted:** 20 Jun 2022; **Published:** 04 Jul 2022

Citation: Gerald C Hsu .(2022). *Viscoelastic or Viscoplastic Glucose Theory (VGT #36): Applying the VEGT or VPGT to Study the Cancer Risk Probability Percentage Versus Medical Conditions and Lifestyle Details over 10+ Years from Y2012 to Y2022 Based on the GH-Method: Math-Physical Medicine (No. 617)*. *J App Mat Sci & Engg Res*, 6(2), 01-07.

Abstract

Since 2012, the author has collected his body weight and finger-piercing glucose values each day. Next, he accumulated medical conditions data including blood pressure (BP), heart rate (HR), and blood lipids along with lifestyle details of diet, exercise, sleep, stress, water intake, and daily routine details. Based on these collected big data, he organized them into two main categories. The first is medical conditions (MC) with 4 categories: weight, glucose, BP, and lipids. The second is lifestyle details (LD) with 6 categories: food, exercise, water intake, sleep, stress, and daily routines. Furthermore, he summarized and calculated the two separate individual category scores of MC and LD.

In this article, the author applies the viscoelasticity and viscoplasticity theories to conduct his research to discover some hidden behavior or relationship between the Cancer risk probability (as an output or strain) versus either MC score or LD score (as inputs or stresses). The hidden behaviors and relationships between the output biomarker of Cancer Risk and the two input biomarkers, MC score and LD score, are time-dependent and change from time to time.

The following two defined equations are used to establish the stress-strain diagram in a space domain (SD):

strain = ϵ
= individual Cancer risk value at the present year

Stress = σ
= $\eta * (d\epsilon/dt)$
= $\eta * (d\text{-strain}/d\text{-time})$
= (viscosity factor η using individual MC score or LD score at present year) * (Cancer risk at present year - Cancer risk at previous year) / 1 year

To offer a simple explanation to readers who do not have a physics or engineering background, the author includes a brief excerpt from Wikipedia regarding the description of basic concepts for elasticity and plasticity theories, viscoelasticity, and viscoplasticity theories from the disciplines of engineering and physics in the Method section.

In summary, the following three observations outline the findings from this research work:

- (1) From the TD waveforms, the correlation between Cancer risk and MC is 96%, while the correlation between Cancer risk and LD is also 96%. This means that the Cancer risk is highly correlated with both MC and LD, but lifestyle is more like a "root cause" for Cancer risk even though many patients with cancer also suffer from other chronic diseases such as obesity, diabetes, hypertension, and hyperlipidemia.
- (2) From the SD stress-strain diagrams between CVD risk vs. MC and CVD risk vs. LD, these two curves are similar in shape and appearance except for their stress scale (y-axis scale) which has a ratio of 1.75 to 1 (-1.4%

for the stress of MC and -0.8% for the stress of LD; or an average MC score of 88% to the average LD score of 50%). This $1.75/1=1.75$ ratio also influences the hysteresis loop area ratio of $0.005/0.003 = 1.72$. In addition, both of these two stress-strain curves demonstrate viscoplastic behavior. Their largest strain change rate (Cancer risk change rate) occurs during the period between Y2012 and Y2017.

(3) The comparisons for the calculated Cancer risk waveform versus two predicted Cancer risk waveforms due to both MC and LD using a viscoelastic perturbation model have shown an extremely high 98% to 99% prediction accuracy. However, **the calculated Cancer risk versus the predicted Cancer risk based on LD has a 96% correlation, while the calculated Cancer risk versus the predicted Cancer risk based on MC has also a 96% correlation.** This 96% of correlation further demonstrates the importance of MC and LD for Cancer risk reduction.

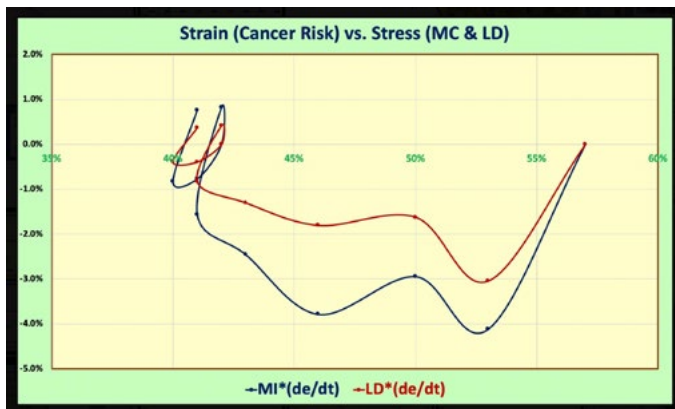

Introduction

Since 2012, the author has collected his body weight and finger-piercing glucose values each day. Next, he accumulated medical conditions data including blood pressure (BP), heart rate (HR), and blood lipids along with lifestyle details of diet, exercise, sleep, stress, water intake, and daily routine details. Based on these collected big data, he organized them into two main categories. The first is medical conditions (MC) with 4 categories: weight, glucose, BP, and lipids. The second is lifestyle details (LD) with 6 categories: food, exercise, water intake, sleep, stress, and daily routines. Furthermore, he summarized and calculated the two separate individual category scores of MC and LD.

In this article, the author applies the viscoelasticity and viscoplasticity theories to conduct his research to discover some hidden behavior or relationship between the Cancer risk probability (as an output or strain) versus either MC score or LD score (as inputs or stresses). The hidden behaviors and relationships between the output biomarker of Cancer Risk and the two input biomarkers, MC score and LD score, are time-dependent and change from time to time.

The following two defined equations are used to establish the stress-strain diagram in a space domain (SD):

$$\begin{aligned} \text{strain} &= \epsilon \\ &= \text{individual Cancer risk value at the present year} \end{aligned}$$

$$\begin{aligned} \text{Stress} &= \sigma \\ &= \eta * (d\epsilon/dt) \\ &= \eta * (d\text{-strain}/d\text{-time}) \\ &= (\text{viscosity factor } \eta \text{ using individual MC score or LD score at present year}) * (\text{Cancer risk at present year} - \text{Cancer risk at previous year}) / 1 \text{ year} \end{aligned}$$

To offer a simple explanation to readers who do not have a physics or engineering background, the author includes a brief excerpt from Wikipedia regarding the description of basic concepts for elasticity and plasticity theories, viscoelasticity, and viscoplasticity theories from the disciplines of engineering and physics in the Method section.

Methods

Elasticity, Plasticity, Viscoelasticity, and Viscoplasticity

The Difference Between Elastic Materials and Viscoelastic Materials

(from "Soborthans, innovating shock and vibration solutions")

What are Elastic Materials?

Elasticity is the tendency of solid materials to return to their original shape after forces are applied on them. When the forces are removed, the object will return to its initial shape and size if the material is elastic.

What are Viscous Materials?

Viscosity is a measure of a fluid's resistance to flow. A fluid with large viscosity resists motion. A fluid with low viscosity flows. For example, water flows more easily than syrup because it has a lower viscosity. High viscosity materials might include honey, syrups, or gels – generally, things that resist flow. Water is a low viscosity material, as it flows readily. Viscous materials are thick or sticky or adhesive. Since heating reduces viscosity, these materials don't flow easily. For example, warm syrup flows more easily than cold.

What is Viscoelastic?

Viscoelasticity is the property of materials that exhibit both viscous and elastic characteristics when undergoing deformation. Synthetic polymers, wood, and human tissue, as well as metals at high temperature, display significant viscoelastic effects. In some applications, even a small viscoelastic response can be significant.

Elastic Behavior Versus Viscoelastic Behavior

The difference between elastic materials and viscoelastic materials is that viscoelastic materials have a viscosity factor and elastic ones don't. Because viscoelastic materials have the viscosity factor, they have a strain rate dependent on time. Purely elastic materials do not dissipate energy (heat) when a load is applied, then removed; however, a viscoelastic substance does.

The following brief introductions are excerpts from Wikipedia

“Elasticity (Physics)”

The physical property is when materials or objects return to their original shape after deformation

In physics and materials science, elasticity is the ability of a body to resist a distorting influence and to return to its original size and shape when that influence or force is removed. Solid objects will deform when adequate loads are applied to them; if the material is elastic, the object will return to its initial shape and size after removal. This is in contrast to plasticity, in which the object fails to do so and instead remains in its deformed state.

The physical reasons for elastic behavior can be quite different for different materials. In metals, the atomic lattice changes size and shape when forces are applied (energy is added to the system). When forces are removed, the lattice goes back to the original lower energy state. For rubbers and other polymers, elasticity is caused by the stretching of polymer chains when forces are applied.

Hooke's law states that the force required to deform elastic objects should be directly proportional to the distance of deformation, regardless of how large that distance becomes. This is known as perfect elasticity, in which a given object will return to its original shape no matter how strongly it is deformed. This is an ideal concept only; most materials that possess elasticity in practice remain purely elastic only up to very small deformations, after which plastic (permanent) deformation occurs.

In engineering, the elasticity of a material is quantified by the elastic modulus such as Young's modulus, bulk modulus, or shear modulus which measure the amount of stress needed to achieve a unit of strain; a higher modulus indicates that the material is harder to deform. The material's elastic limit or yield strength is the maximum stress that can arise before the onset of plastic deformation.

Plasticity (Physics)

Deformation of a solid material undergoing non-reversible changes of shape in response to applied forces.

In physics and materials science, **plasticity**, also known as **plastic deformation**, is the ability of a solid material to undergo permanent deformation, a non-reversible change of shape in response to applied forces. For example, a solid piece of metal being bent or pounded into a new shape displays plasticity as permanent changes occur within the material itself. In engineering, the transition from elastic behavior to plastic behavior is known as yielding.

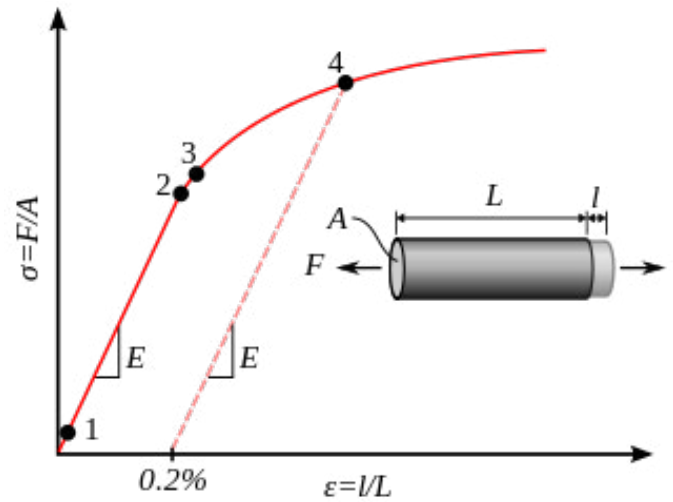

A stress-strain curve showing typical yield behavior for nonferrous alloys.

1. True elastic limit
2. Proportionality limit
3. Elastic limit
4. Offset yield strength

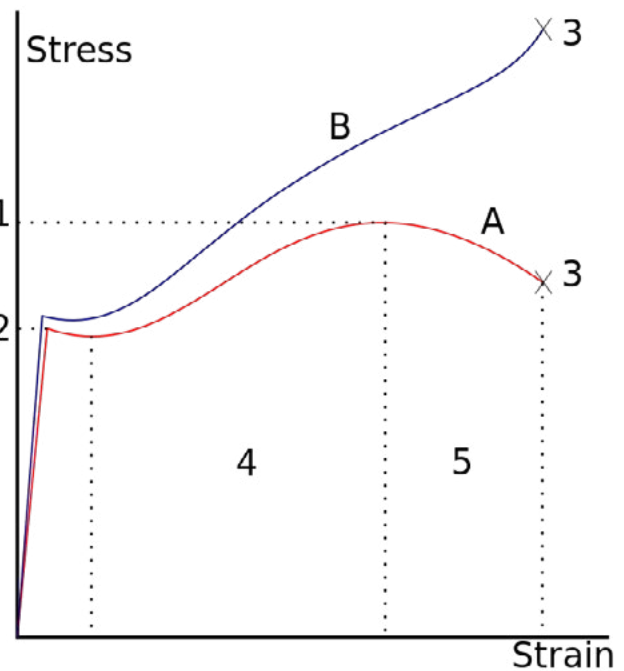

A stress-strain is typical of structural steel.

- 1: Ultimate strength
- 2: Yield strength (yield point)
- 3: Rupture
- 4: Strain hardening region
- 5: Necking region
- A: Apparent stress (F/A_0)
- B: Actual stress (F/A)

Plastic deformation is observed in most materials, particularly metals, soils, rocks, concrete, and foams. However, the physical mechanisms that cause plastic deformation can vary widely. At a crystalline scale, plasticity in metals is usually a consequence

of dislocations. Such defects are relatively rare in most crystalline materials, but are numerous in some and part of their crystal structure; in such cases, plastic crystallinity can result. In brittle materials such as rock, concrete, and bone, plasticity is caused predominantly by slip at microcracks. In cellular materials such as liquid foams or biological tissues, plasticity is mainly a consequence of bubble or cell rearrangements, notably TI processes.

For many ductile metals, tensile loading applied to a sample will cause it to behave in an elastic manner. Each increment of the load is accompanied by a proportional increment in extension. When the load is removed, the piece returns to its original size. However, once the load exceeds a threshold – the yield strength – the extension increases more rapidly than in the elastic region; now when the load is removed, some degree of the extension will remain.

Elastic deformation, however, is an approximation and its quality depends on the time frame considered and loading speed. If, as indicated in the graph opposite, the deformation includes elastic deformation, it is also often referred to as "elasto-plastic deformation" or "elastic-plastic deformation".

Perfect plasticity is a property of materials to undergo irreversible deformation without any increase in stresses or loads. Plastic materials that have been hardened by prior deformation, such as cold forming, may need increasingly higher stresses to deform further. Generally, plastic deformation is also dependent on the deformation speed, i.e. higher stresses usually have to be applied to increase the rate of deformation. Such materials are said to deform visco-plastically."

Viscoelasticity

Property of materials with both viscous and elastic characteristics under deformation

In materials science and continuum mechanics, viscoelasticity is the property of materials that exhibit both viscous and elastic characteristics when undergoing deformation. Viscous materials, like water, resist shear flow and strain linearly with time when a stress is applied. Elastic materials strain when stretched and immediately return to their original state once the stress is removed.

Viscoelastic materials have elements of both of these properties and, as such, exhibit time-dependent strain. Whereas elasticity is usually the result of bond stretching along crystallographic planes in an ordered solid, viscosity is the result of the diffusion of atoms or molecules inside an amorphous material.

In the nineteenth century, physicists such as Maxwell, Boltzmann, and Kelvin researched and experimented with creep and recovery of glasses, metals, and rubbers. Viscoelasticity was further examined in the late twentieth century when synthetic polymers were engineered and used in a variety of applications. Viscoelasticity calculations depend heavily on the viscosity variable, η . The inverse of η is also known as fluidity, ϕ . The value of either can be derived as a function of temperature or as a given

value (i.e. for a dashpot).

Depending on the change of strain rate versus stress inside a material, the viscosity can be categorized as having a linear, non-linear, or plastic response. When a material exhibits a linear response it is categorized as a Newtonian material. In this case the stress is linearly proportional to the strain rate. If the material exhibits a non-linear response to the strain rate, it is categorized as Non-Newtonian fluid. There is also an interesting case where the viscosity decreases as the shear/strain rate remains constant. A material that exhibits this type of behavior is known as thixotropic. In addition, when the stress is independent of this strain rate, the material exhibits plastic deformation. Many viscoelastic materials exhibit rubber-like behavior explained by the thermodynamic theory of polymer elasticity.

Cracking occurs when the strain is applied quickly and outside of the elastic limit. Ligaments and tendons are viscoelastic, so the extent of the potential damage to them depends both on the rate of the change of their length as well as on the force applied.

A viscoelastic material has the following properties:

- **hysteresis is seen in the stress–strain curve**
- **stress relaxation occurs: step constant strain causes decreasing stress**
- **creep occurs: step constant stress causes increasing strain**
- **its stiffness depends on the strain rate or the stress rate.**

Elastic Versus Viscoelastic Behavior

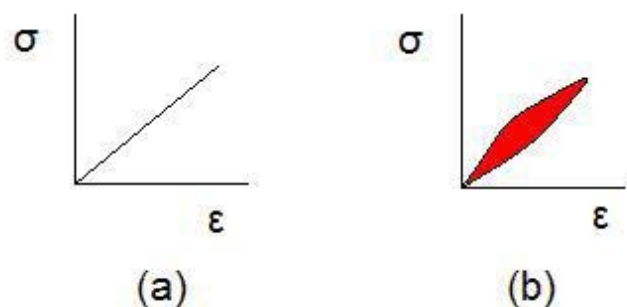

elastic material (b). The red area is a hysteresis loop and shows the amount of energy lost (as heat) in a loading and unloading cycle. It is equal to

$$\oint \sigma d\epsilon$$

where σ is stress and ϵ is strain.

Unlike purely elastic substances, a viscoelastic substance has an elastic component and a viscous component. **The viscosity of a viscoelastic substance gives the substance a strain rate dependence on time.** Purely elastic materials do not dissipate energy (heat) when a load is applied, then removed. However, a viscoelastic substance dissipates energy when a load is **applied, then removed. Hysteresis is observed in the stress–strain curve, with the area of the loop being equal to the energy lost during the loading cycle.** Since viscosity is the resistance to thermally activated plastic deformation, a viscous material will lose energy through a loading cycle. Plastic deformation results in lost energy, which is uncharacteristic of a purely elastic material's reaction to a loading cycle.

Specifically, viscoelasticity is a molecular rearrangement. When a stress is applied to a viscoelastic material such as a polymer, parts of the long polymer chain change positions. This movement or rearrangement is called “creep”. Polymers remain a solid material even when these parts of their chains are rearranging in order to accompany the stress, and as this occurs, it creates a back stress in the material. When the back stress is the same magnitude as the applied stress, the material no longer creeps. When the original stress is taken away, the accumulated back stresses will cause the polymer to return to its original form. **The material creeps, which gives the prefix visco-, and the material fully recovers, which gives the suffix -elasticity.**

Viscoplasticity

Viscoplasticity is a theory in continuum mechanics that describes the rate-dependent inelastic behavior of solids. Rate-dependence in this context means that the deformation of the material depends on the rate at which loads are applied. The inelastic behavior that is the subject of viscoplasticity is plastic deformation which means that the material undergoes unrecoverable deformations when a load level is reached. Rate-dependent plasticity is important for transient plasticity calculations. The main difference between rate-independent plastic and viscoplastic material models is that the latter exhibit not only permanent deformations after the application of loads but continue to undergo a creep flow as a function of time under the influence of the applied load.

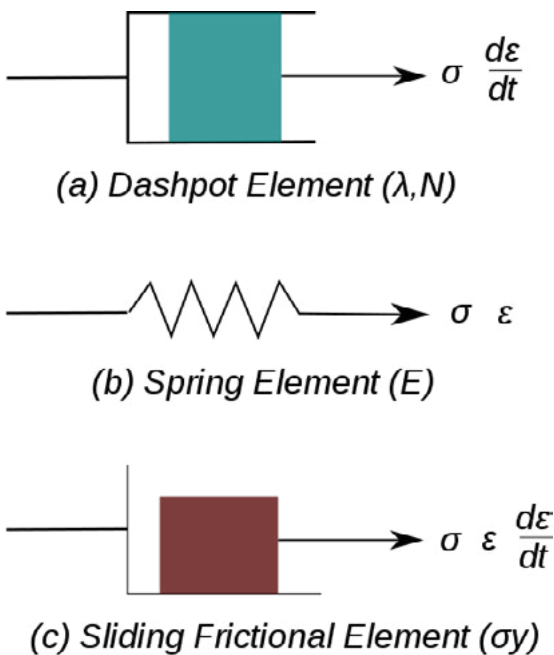

Figure 1. Elements used in one-dimensional models of viscoplastic materials.

The elastic response of viscoplastic materials can be represented in one dimension by Hookean spring elements. Rate-dependence can be represented by nonlinear dashpot elements in a manner similar to viscoelasticity. Plasticity can be accounted for by adding sliding frictional elements as shown in Figure 1. In figure E is the modulus of elasticity, λ is the viscosity parameter and N is a power-law type parameter that represents non-linear dashpot [$\sigma(d\epsilon/dt) = \sigma = \lambda(d\epsilon/dt)^{1/N}$]. The sliding element can have a

yield stress (σ_y) that is strain rate dependent, or even constant, as shown in Figure 1c.

Viscoplasticity is usually modeled in three dimensions using overstress models of the Perzyna or Duvaut-Lions types. In these models, the stress is allowed to increase beyond the rate-independent yield surface upon application of a load and then allowed to relax back to the yield surface over time. The yield surface is usually assumed not to be rate-dependent in such models. An alternative approach is to add a strain rate dependence to the yield stress and use the techniques of rate-independent plasticity to calculate the response of a material.

For metals and alloys, viscoplasticity is the macroscopic behavior caused by a mechanism linked to the movement of dislocations in grains, with superposed effects of inter-crystalline gliding. The mechanism usually becomes dominant at temperatures greater than approximately one-third of the absolute melting temperature. However, certain alloys exhibit viscoplasticity at room temperature (300K). For polymers, wood, and bitumen, the theory of viscoplasticity is required to describe behavior beyond the limit of elasticity or viscoelasticity.

In general, viscoplasticity theories are useful in areas such as

- the calculation of permanent deformations,
- the prediction of the plastic collapse of structures,
- the investigation of stability,
- crash simulations,
- systems exposed to high temperatures such as turbines in engines, e.g. a power plant,
- dynamic problems and systems exposed to high strain rates.

Phenomenology

For qualitative analysis, several characteristic tests are performed to describe the phenomenology of viscoplastic materials. Some examples of these tests are

1. hardening tests at constant stress or strain rate,
2. creep tests at constant force, and
3. stress relaxation at constant elongation.

Strain Hardening Test

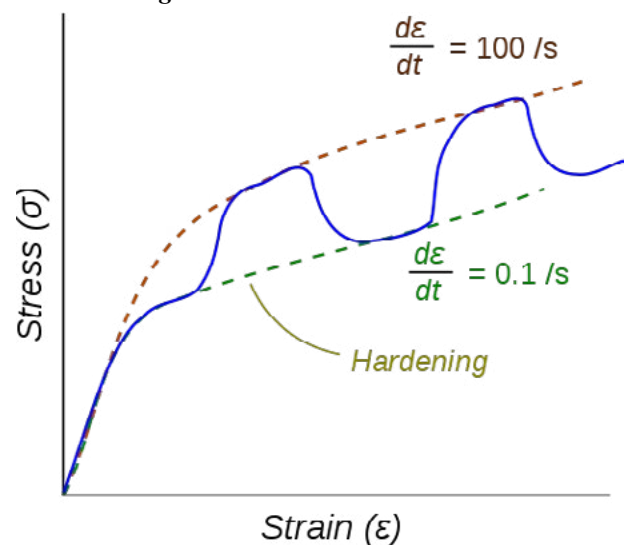

Figure 2. Stress-strain response of a viscoplastic material at different strain rates.

The dotted lines show the response if the strain rate is held constant. The blue line shows the response when the strain rate is changed suddenly.

One consequence of yielding is that as plastic deformation proceeds, an increase in stress is required to produce additional strain. This phenomenon is known as Strain/Work hardening. For a viscoplastic material, the hardening curves are not significantly different from those of rate-independent plastic material. Nevertheless, three essential differences can be observed.

1. At the same strain, the higher the rate of strain the higher the stress
2. A change in the rate of strain during the test results in an immediate change in the stress-strain curve.
3. The concept of a plastic yield limit is no longer strictly applicable.

The hypothesis of partitioning the strains by decoupling the

elastic and plastic parts is still applicable where the strains are small, i.e.,

$$\epsilon = \epsilon_e + \epsilon_{vp}$$

where ϵ_e is the elastic strain and ϵ_{vp} is the viscoplastic strain. To obtain the stress-strain behavior shown in blue in the figure, the material is initially loaded at a strain rate of 0.1/s. The strain rate is then instantaneously raised to 100/s and held constant at that value for some time. At the end of that period, the strain rate is dropped instantaneously back to 0.1/s and the cycle is continued for increasing values of strain. There is clearly a lag between the strain-rate change and the stress response. This lag is modeled quite accurately by overstress models (such as the Perzyna model) but not by models of rate-independent plasticity that have a rate-dependent yield stress.”

Results

Figure 1 displays the data table and calculated results of this study.

2/28/22	Strain	Stress	eta	Pred. Strain	Hysteresis
Period	Cancer Risk	MI*(de/dt)	Medical Conditions	Pert. CVD (MI)	Loop Area
Y2012	57%	0.0%	109%	57%	0.00
Y2013	53%	-4.1%	103%	49%	0.00
Y2014	50%	-2.9%	98%	47%	0.00
Y2015	46%	-3.8%	95%	42%	0.00
Y2016	43%	-2.5%	82%	41%	0.00
Y2017	41%	-1.6%	78%	39%	0.00
Y2018	42%	0.8%	83%	43%	0.00
Y2019	42%	0.0%	87%	42%	0.00
Y2020	41%	-0.8%	77%	40%	0.00
Y2021	40%	-0.8%	82%	39%	0.00
Y2022	41%	0.8%	77%	42%	0.00
Average	45%	-1.4%	88%	44%	
Accuracy				98%	
Correlation			96%	95%	
Loop Area					0.005

2/1/22	Strain	Stress	eta	Pred. Strain	Hysteresis
Period	Cancer Risk	LD*(de/dt)	Lifestyle Details	Pert. CVD (LD)	Loop Area
Y2012	57%	0.0%	90%	57%	0.00
Y2013	53%	-3.0%	76%	50%	0.00
Y2014	50%	-1.6%	54%	48%	0.00
Y2015	46%	-1.8%	45%	44%	0.00
Y2016	43%	-1.3%	43%	42%	0.00
Y2017	41%	-0.8%	41%	40%	0.00
Y2018	42%	0.4%	42%	42%	0.00
Y2019	42%	0.0%	43%	42%	0.00
Y2020	41%	-0.4%	39%	41%	0.00
Y2021	40%	-0.4%	39%	40%	0.00
Y2022	41%	0.4%	37%	41%	0.00
Average	45%	-0.8%	50%	44%	
Accuracy				99%	
Correlation			96%	98%	
Loop Area					0.003

Figure 1: Data table and calculation results of this study

Figure 2 shows the high correlation in TD between cancer risk versus both medical conditions and lifestyle details.

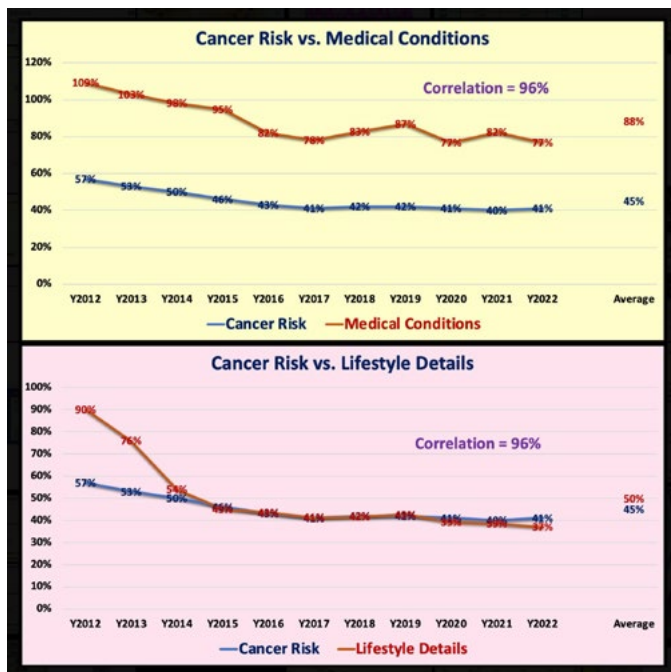

Figure 2: Comparison of Cancer risk vs. MC and Cancers risk vs. LD

Figure 3 depicts the results of two stress-strain diagrams based on MC and LD, respectively, from the viscoelastic or viscoplastic study for this case.

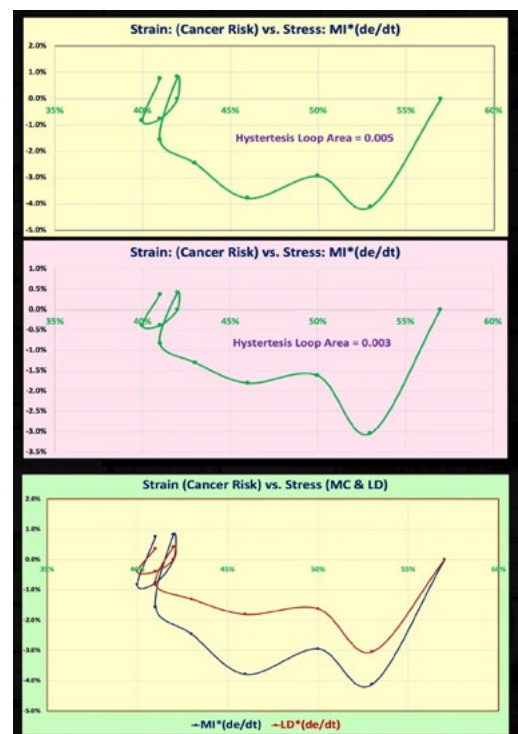

Figure 3: Viscoplastic stress-strain diagrams

Figure 4 reveals the comparison between calculated CVD risk versus two predicted CVD risks using the viscoelastic perturbation model.

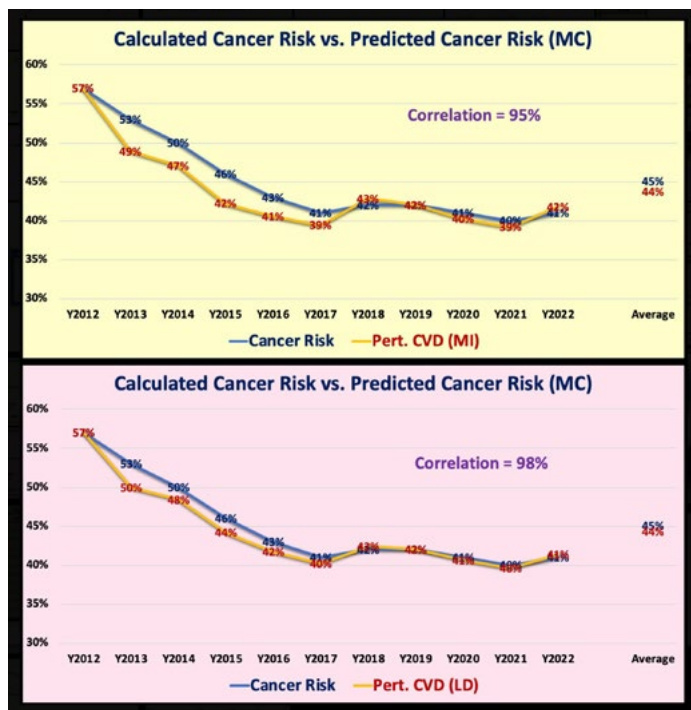

Figure 4: Predicted cancer risk using visco-perturbation model vs. calculated cancer risk

Conclusion

In summary, the following three observations outline the findings from this research work:

(1) From the TD waveforms, the correlation between Cancer risk and MC is 96%, while the correlation between Cancer risk and LD is also 96%. This means that the Cancer risk is highly

correlated with both MC and LD, but lifestyle is more like a “root cause” for Cancer risk even though many patients with cancer also suffer from other chronic diseases such as obesity, diabetes, hypertension, and hyperlipidemia.

(2) From the SD stress-strain diagrams between CVD risk vs. MC and CVD risk vs. LD, these two curves are similar in shape and appearance except for their stress scale (y-axis scale) which has a ratio of 1.75 to 1 (-1.4% for the stress of MC and -0.8% for the stress of LD; or an average MC score of 88% to the average LD score of 50%). This 1.75/1=1.75 ratio also influences the hysteresis loop area ratio of 0.005/0.003 = 1.72. In addition, both of these two stress-strain curves demonstrate viscoplastic behavior. Their largest strain change rate (Cancer risk change rate) occurs during the period between Y2012 and Y2017.

(3) The comparisons for the calculated Cancer risk waveform versus two predicted Cancer risk waveforms due to both MC and LD using a viscoelastic perturbation model have shown an extremely high 98% to 99% prediction accuracy. However, the calculated Cancer risk versus the predicted Cancer risk based on LD has a 96% correlation, while the calculated Cancer risk versus the predicted Cancer risk based on MC has also a 96% correlation. This 96% of correlation further demonstrates the importance of MC and LD for Cancer risk reduction.

References

For editing purposes, the majority of the references in this paper, which are self-references, have been removed. Only references from other authors' published sources remain. The bibliography of the author’s original self-references can be viewed at www.eclaircmd.com.

Readers may use this article as long as the work is properly cited, their use is educational and not for profit, and the author’s original work is not altered.

Copyright: ©2022 Gerald C Hsu. This is an open-access article distributed under the terms of the Creative Commons Attribution License, which permits unrestricted use, distribution, and reproduction in any medium, provided the original author and source are credited.